

Lexicomm ViLX-228N EVCS Master Station

LX228N Repeater Schematic

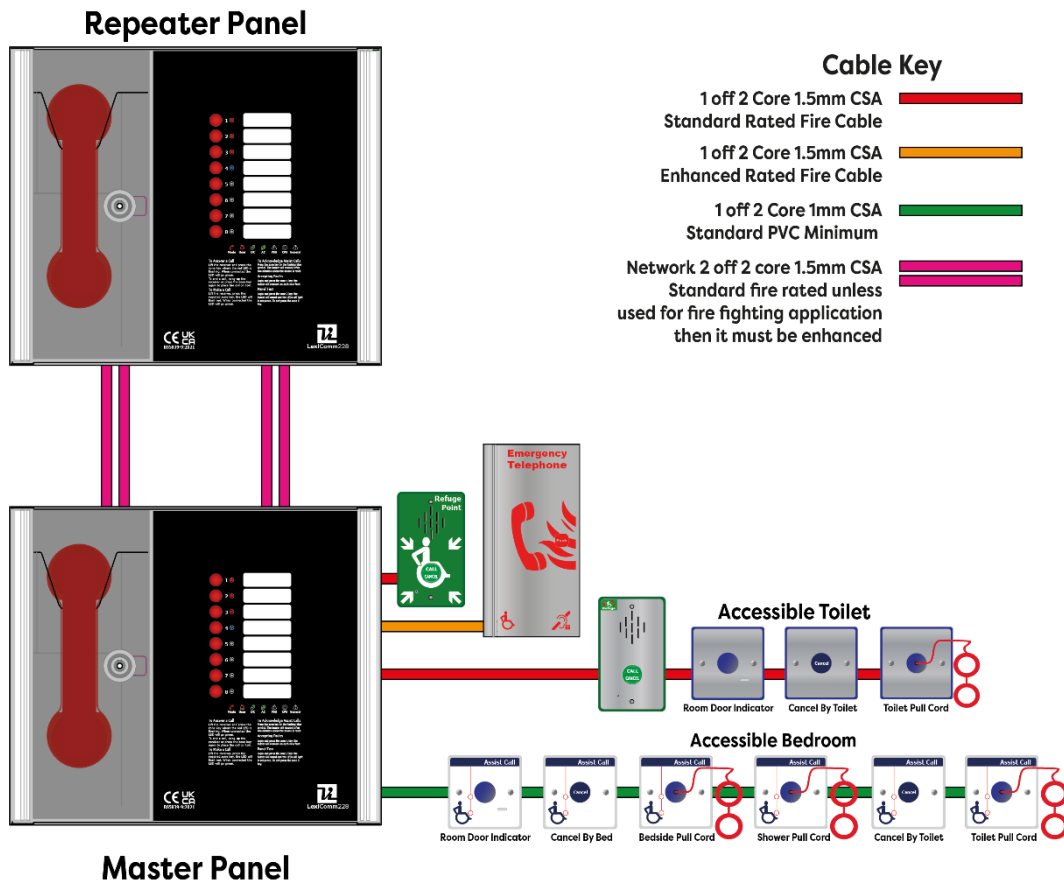

Installation and Commissioning Manual Version 2 September 2025

Table of Contents

1 Introduction	3
1.1 What is an Emergency Voice Communication System?	3
1.2 Suitability	3
2 Product Overview	3
3 Important Safety Information	4
4 Unpacking the Unit	5
5 Installation	6
5.1 Connecting the ViLX-228N Master Station	7
5.2 Planning the Wiring	7
5.3 Cable and Wiring Guidance	7
5.4 Cabling methods	7
5.5 Mains Connection	9
5.6 Battery Information	10
5.7 Outstation Connections	10
5.8 Auxiliary Connections	13
5.9 Powering up procedure	13
5.10 Powering down procedure	13
6 Set-up Procedure	14
6.1 ViLX-228N Master Station Display PCB Dipswitch Settings	14
6.2 Adding a Line Card	15
6.3 Removing a Line card	15
6.4 Adding a ViLX-228N Repeater Station	15
ViLX-228N Master Station Exchange PCB Dipswitch Settings	16
6.5 Login Procedure	16
6.6 Fault Accept	16
6.7 Panel Indicator Test	17
6.8 Extended Fault Menu	17
6.9 In Use Relay Options	18
6.10 Remote Signal Delay Timer	18
7 Operation	18
7.1 Receiving a call	18
7.2 Making a call	19
7.3 Ending a call	19
7.4 Putting a call on hold	19
7.5 Conference Call	19
7.6 Acknowledging AssistCall alarms	19
7.7 Accepting Faults	19
7.8 Panel Indicator Test	19
8 Indications and Controls	20
8.1 Indicator Icons Key	20
8.2 Mode Indicator Summary	20
8.3 Power supply and CPU indicator Summary	21
8.4 User Indicator Summary	21
8.5 Zone indicator summary	22
9 Commissioning procedure	23
10 Maintenance	23
11 Outstation zone template	24
12 Technical Specification	25

1 Introduction

1.1 What is an Emergency Voice Communication System?

An Emergency Voice Communication System, or EVCS, is a system that allows voice communication in either direction between a central control point and a number of other points throughout a building or building complex, particularly in a fire emergency situation. The control points, or outstations by which they are more commonly referred, generally comprise of a Type A outstation, a Type B outstation, or a Type C Combined Type outstation. AssistCall emergency assistance alarm systems can also be incorporated into the EVCS.

EVCS is generally required in the following situations:

- In any building or sports or similar venue where there are disabled people, or people who may have difficulty negotiating the evacuation route.
- In buildings with phased evacuation and/or firefighting lifts where it facilitates secure communications for building managers, fire wardens, and attending fire officers.
- At sports venues and similar complexes, where it will assist stewards in controlling the evacuation of the area in an emergency.

The Lexicomm ViLX-228N Emergency Voice Communications System (EVCS) is designed to fully comply with BS 5839-9:2021 for use as a Fire Telephone system, Disabled Refuge Call system or as a combined system when both Fire Telephones and Disabled Refuge Points are required.

1.2 Suitability

Fire telephone systems are recommended for all public buildings and multi-story buildings over four floors by BS 9999.

Disabled Refuge systems are required in buildings where the public or disabled staff gains access to any floor other than the ground floor using lifts. Refuge areas are provided at each storey exit from each protected stairway.

2 Product Overview

The Lexicomm EVCS, or ViLX-228N, comprises of a Master Station and one or more outstations. Additionally, the AssistCall emergency assistance alarm system can either be connected to the same line as a Type B outstation, or connected to a dedicated line. Neither the outstations nor the AssistCall emergency alarm system requires a separate power supply unit as each line is powered from the Master Station. This has the additional benefit of each line being fully monitored and battery backed up.

Each ViLX-228N Master Station can also perform as a ViLX-228N Repeater Station. A ViLX-228N Repeater Station mimics the ViLX-228N Master Station both in operation and indication. Any reference in this document to the ViLX-228N Master Station also applies to the ViLX-228N Repeater Station, unless specified otherwise.

The ViLX-228N Master Station has been designed for radial star topology. In most cases this will reduce the cable requirements for all ring-based systems. The topology consists of spurs formed of 1 off two core 1.5mm CSA cables (soft skin enhanced up to 500m per leg, MICC 200m per leg) to each outstation.

3 Important Safety Information

This Equipment must only be installed and maintained by a suitably skilled and competent person.

This Equipment is defined as Class 1 in EN IEC62368-1:2020+A11:2020 (Low Voltage Directive) and must be EARTHED.



Caution



Indoor Use Only



Warning

Shock Hazard-
Isolate Before Opening

Warning

TO REDUCE THE RISK OF FIRE OR
ELECTRIC SHOCK, DO NOT EXPOSE
THIS UNIT TO RAIN OR MOISTURE

Warning

THIS UNIT MUST BE EARTHED

Warning

NO USER SERVICEABLE PARTS

Each ViLX-228N Master Station requires local isolation with verification as per the Electricity at Work Regulations 1989, returning to a B6A breaker clearly marked "**EMERGENCY VOICE COMMUNICATION SYSTEM. DO NOT TURN OFF**".



Anti-static handling guidelines

Make sure that electrostatic handling precautions are taken immediately before handling PCBs and other static sensitive components.

Before handling any static-sensitive items, operators should get rid of any electrostatic charge by touching a sound safety earth. Always handle PCBs by their sides and avoid touching any components.

4 Unpacking the Unit

Remove the ViLX-228N Master Station from its packing, and check the contents against the following list:

- ViLX-228N Master Station.
- Installation & maintenance manual (this document).
- Quick start Guide.
- Accessory pack with the following contents: -
 - 1× 2.5mm AF Hex Key.
 - 1× door handle/key.
 - 10kΩ End of Line (EoL) Resistors, 2 per line card

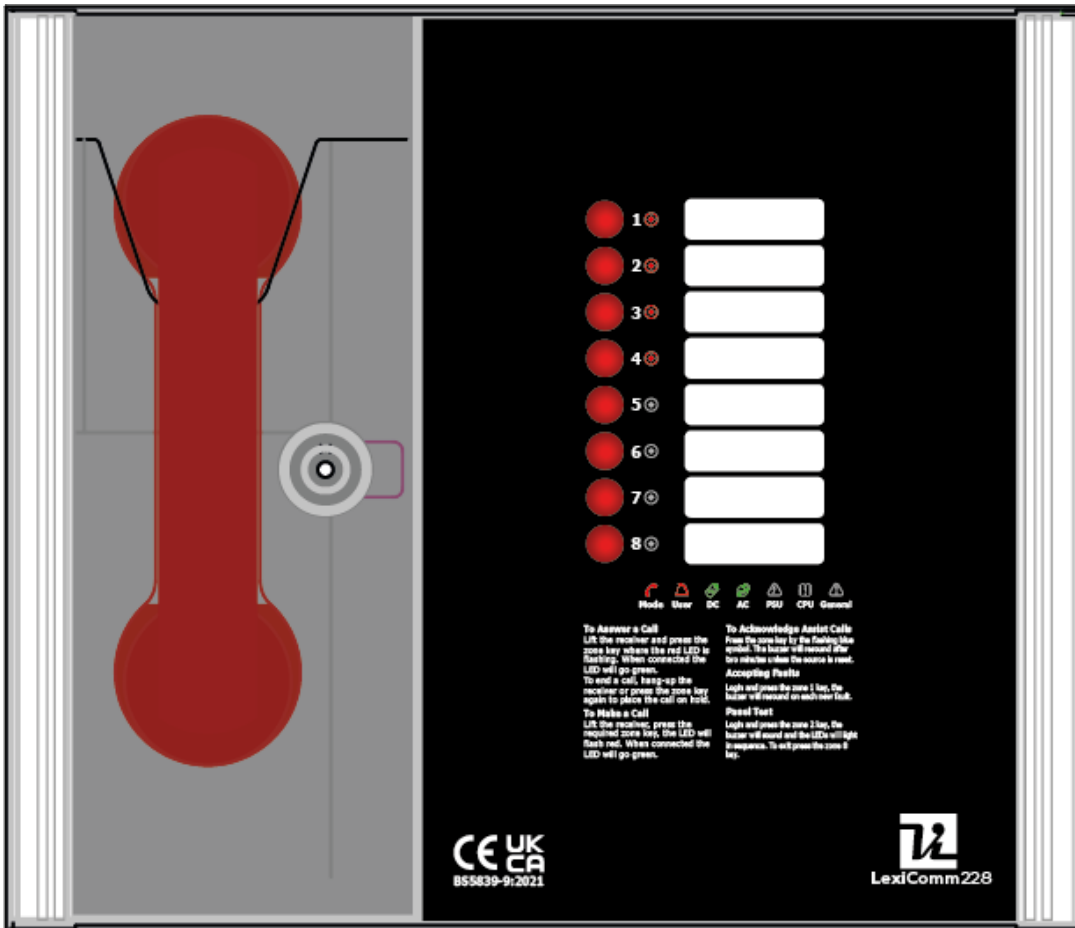

Figure 1

Use the 2.5mm AF Hex Key supplied to open the right-hand front cover.

Verify the following items are present:

- Correct number of Line Card, depending on configuration. Complete with 2-way line connectors.
- 1 × 3-way mains connector.
- 1 × 2-way Fault connector.
- 1 × 2-way In Use connector.
- 1 × 2-way Enable connector.
- 4 × 2-way Network connectors.
- 1 × Battery lead.

If there are any items missing, please contact your supplier or Vox Ignis Limited, quoting the unit serial number and the name on the packing list enclosed, so the situation can be rectified.

5 Installation

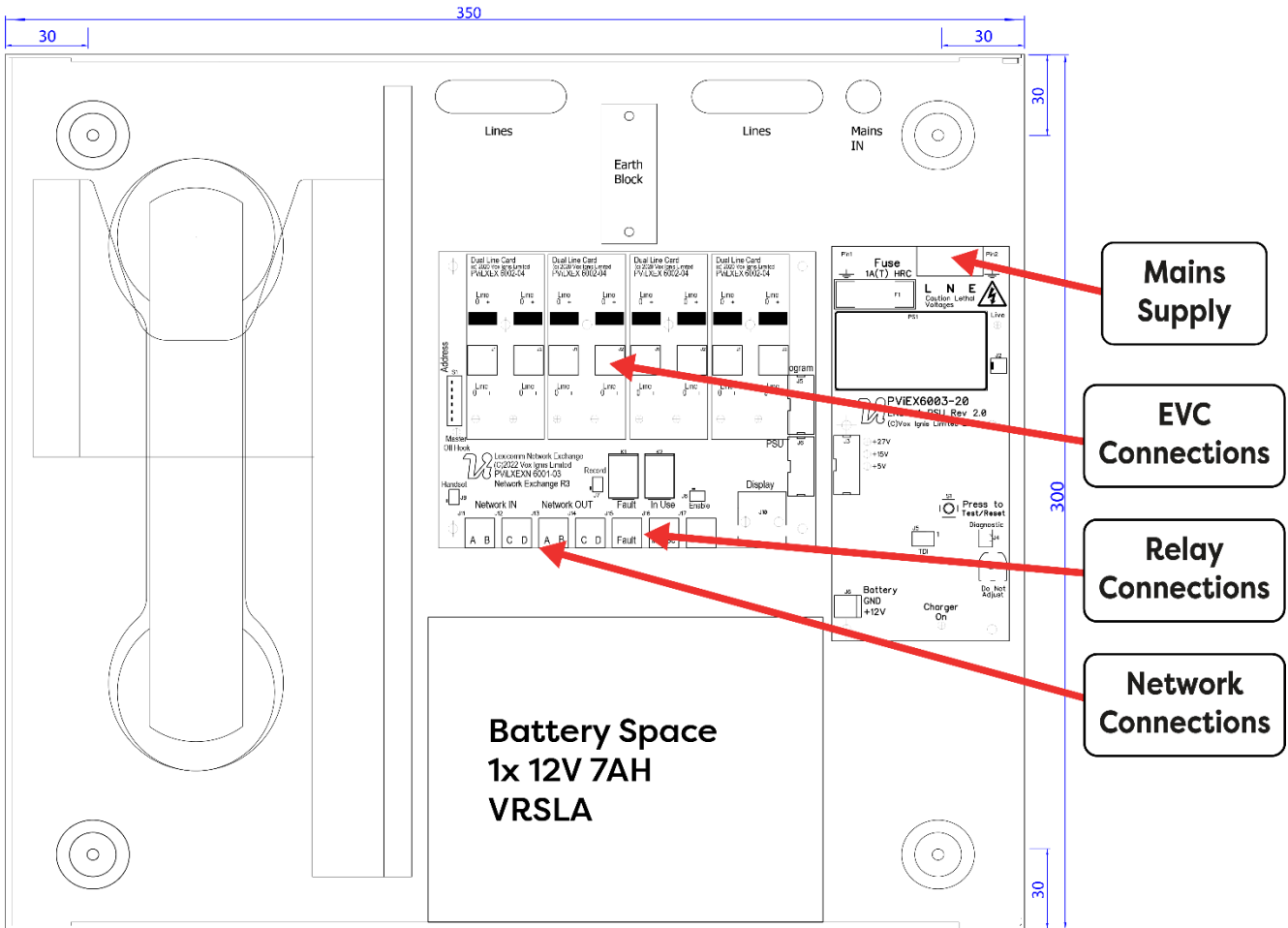

Figure 2

Prior to mounting the ViLX-228N Master Station, it should be decided if the field wiring is to be run on the surface or concealed. There are 14 knockouts on the top and 2 slotted entries with a dedicated mains supply entry at the rear. If a knockout is removed by mistake, fill the hole with a good quality cable gland.

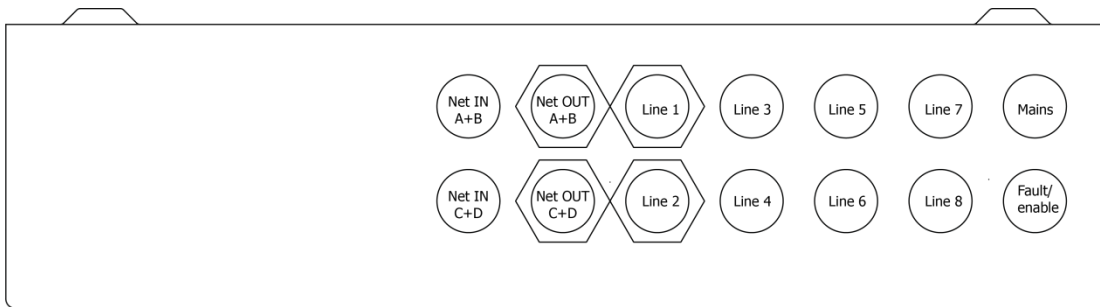

Figure 3

Unused knockouts must be left unopened to comply with the Low Voltage Directive. Accidentally knocked out holes should be blanked off.

The ViLX-228N Master Station weighs 6kg with batteries, so care should be taken to securely mount the Station on stud walling.

5.1 Connecting the ViLX-228N Master Station

To comply with EMC (Electro Magnetic Compatibility) regulations and to reduce the risk of electrical interference in the system wiring, the use of fire-resistant screened cables is recommended throughout the installation.

All wiring should come into the enclosure via the knockouts provided and be fixed tidily to the relevant terminals.

Note that correct cable glanding is essential. Due regard should be paid to any system specifications which demand a certain cable type, providing it meets the appropriate national wiring regulations.

5.2 Planning the Wiring

All system wiring should be installed to meet the appropriate parts of BS 5839-9:2021 and BS 7671 (Wiring Regulations). Other national standards of installation should be adhered to where applicable.



Do not test wiring using an insulation tester (Megger) with any equipment connected, as the 500 Volt test voltage will destroy these devices.

You must observe local wiring regulations. Do not run SELV and LV cables in the same enclosure without adequate insulation between them.

5.3 Cable and Wiring Guidance

5.3.1 Fire Telephone system

Any system using Type A outstations must use enhanced grade cabling throughout for all wiring, including the mains supply to the ViLX-228N Master Station.

5.3.2 Disabled Refuge EVC System

For buildings less than 30m in height, or any building with sprinklers fitted, standard grade fire resistant cable may be used to wire Type B outstation and the mains supply to the Master Station as long as the planned evacuation will be completed in 30 minutes.

If the building is over 30m in height without sprinklers, or where the evacuation will take place over multiple stages exceeding 30 minutes, then enhanced grade cables must be used.

5.3.3 Combined Systems

For systems containing Type A, Type B or Type C outstations, shared cable such as network cables must be enhanced grade.

Cabling to Type A or Type C outstations must be in enhanced grade fire resistant cabling.

Individual spurs to Type B outstations can be wired in standard grade fire resistant cabling in accordance with the wiring guidelines already set out for disabled refuge systems.

5.3.4 AssistCall Emergency Assistance Alarm Systems

All installations must conform to Building Regulations Approved Document M. The AssistCall is wired using 2 core cable, and the AssistCall plates can be wired in any order.

5.4 Cabling methods

There are 3 cabling methods available:

- Connection to a Type A or Type C outstation: use 2 core enhanced grade fire resistant cable when extending a firefighting telephone system.
- Connection to a Type B outstation: use 2 core standard grade fire resistant cable when extending a disabled refuge system.
- Connection to an AssistCall system on a dedicated line requires 2 core 1mm CSA or above PVC sheathed.

5.4.1 ViLX-228N Wiring Examples

Two ViLX-228N panels can be wired together in a ring to operate as Master/Repeater pair, with each outpostion/alarm connected via a radial circuit to either the Master Station or Repeater Station. The full layout for the network wiring can be seen below in Figure 6. If the repeater panel has no lines wired into it, the layout will be as follows.

LX228N Repeater Schematic

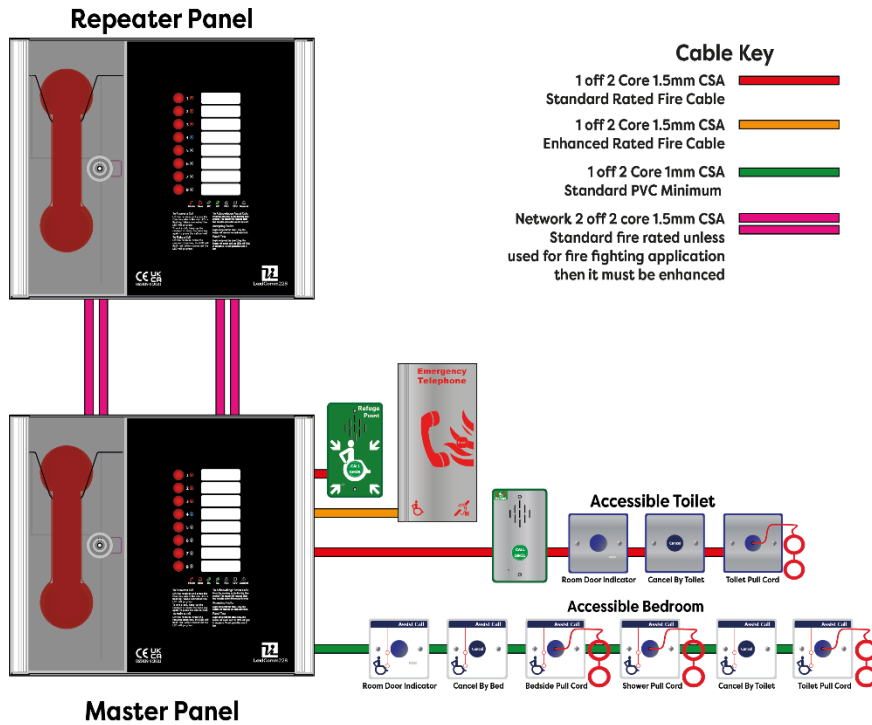

Figure 4

The lines can be shared across the two panels in either a 2-6 or 4-4 formation. Each linecard position must only be used once across both panels (Figure 5 shows one panel using positions 1&2, the other using 3&4). All 8 lines will be shown on both panels when activated.

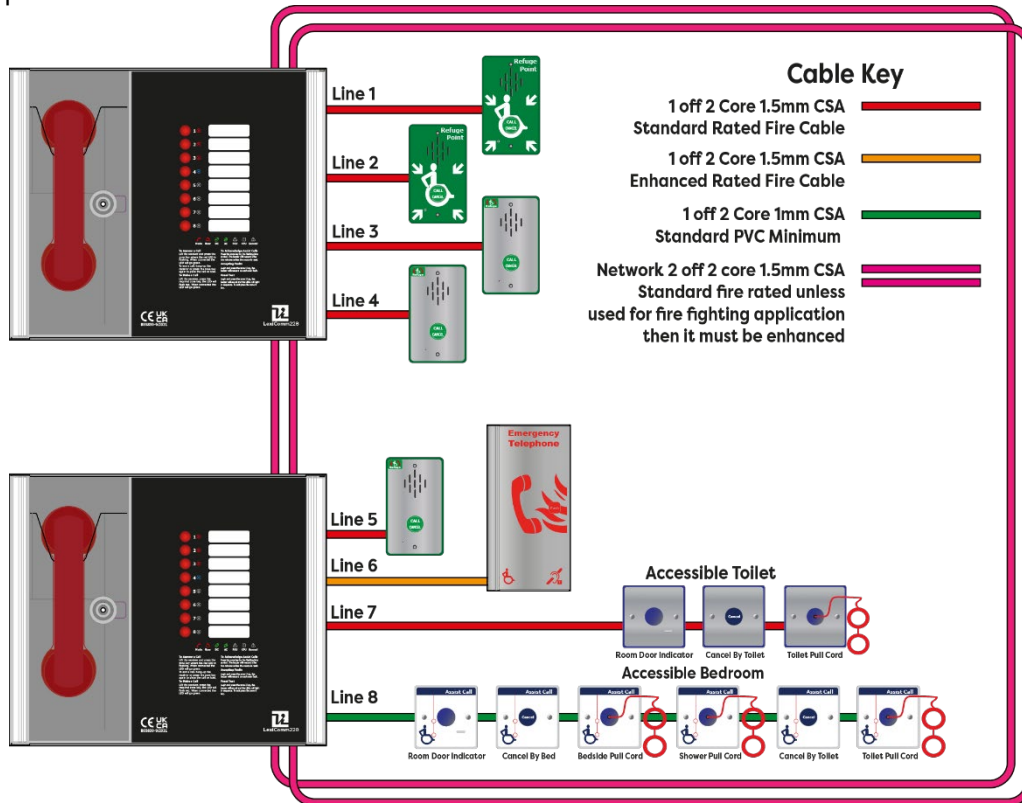

Figure 5

5.4.1.1 Network Wiring

The network connections between a pair of Master/Repeater panels is shown below, with the Master's net in pair connected to the Repeater's net out pair and the Repeater's net out pair connected to the Master's net out pair. If the 228N is being used as part of a larger LexicommPro network with ViLX-TMS3 and ViLX-EX8 panels, it is networked the same way they are.

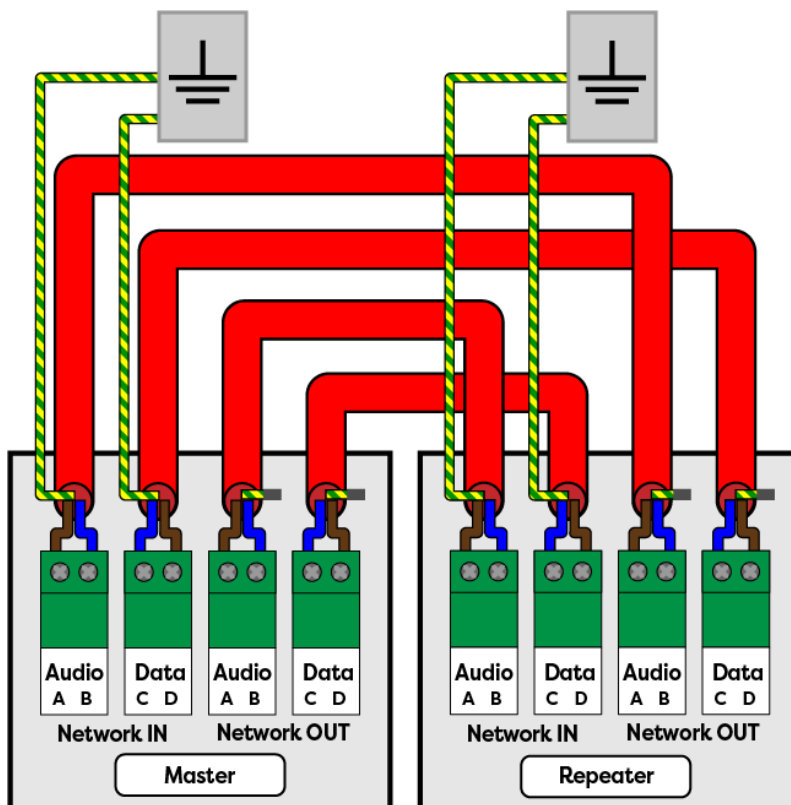

Figure 6



Note: Only connect the earth screens on the Net in cables, cut back and insulate Net OUT earth screens

5.5 Mains Connection

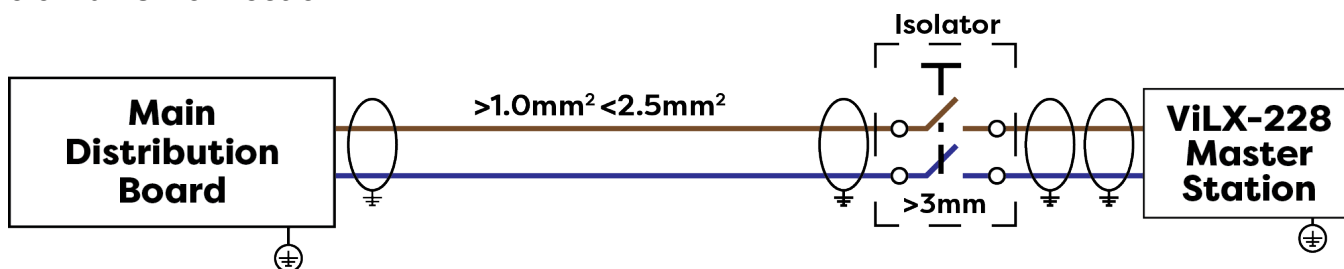

Figure 7

Each ViLX-228N Master Station requires local isolation with verification as per the Electricity at Work Regulations 1989, returning to a B6A breaker clearly marked **“EMERGENCY VOICE COMMUNICATION SYSTEM. DO NOT TURN OFF”**.

If the ViLX-228N Master Station and the ViLX-228N Repeater Station are distributed around a site, it is essential that both ViLX-228N Stations are on the same mains phase, as they are classified TN-S 230V. Powering from different phases can mean a 440V potential can be present in a ViLX-228N Station during a major fault incident.

5.6 Battery Information

In the event of mains failure BS 5839-9:2021 requires battery backup for 24 hours standby and 3 hours operation thereafter.

A ViLX-228N Master/Repeater Station requires **one number** 12V 7AH vent regulated sealed lead acid battery. The battery is not supplied with the ViLX-228N Master/Repeater Station.



Safety Information:

Sealed Lead Acid batteries contain sulphuric acid which can cause burns if exposed to the skin. The low internal resistance of these batteries mean large currents will flow if they are accidentally short-circuited causing burns and a risk of fire.

Exercise caution when handling batteries.

Power Up Procedure:

Always apply mains power before connecting batteries.

When connecting batteries, always connect the Positive (Red +) terminal first.

Power Down Procedure:

Disconnect the batteries before removing the mains power.

When disconnecting batteries, always remove the Negative (Black –) terminal first.

Battery leads should be removed by grasping the plastic battery spade connector covers not the red and black wires as this can cause premature failure of the lead.

5.7 Outstation Connections

The ViLX-228N Master Station is equipped with at least one number Dual line card. One outstation per line output can be connected. If no outstation is connected to the line output, then an end of line 10kΩ resistor should be fitted. The dipswitch located on the rear of the door mounted Display PCB is used for configuration see 6.1

The following devices are available on the system:

- Type A (fixed phone)
- Type B (hands-free refuge point)
- Type C “Combi” (combined Type A and Type B)
- Jack point
- AssistCall emergency assistance alarm system.

For Type A, Type B, and Type C outstations, the end-of-line 10kΩ resistor should be removed from the accessory pack and connected to the end-of-line terminal in the outstation.

For Jack points and the AssistCall system, the end-of-line 10kΩ resistor should also be removed from the accessory pack and connected to the last plate on the system.

5.7.1 Type A Outstation

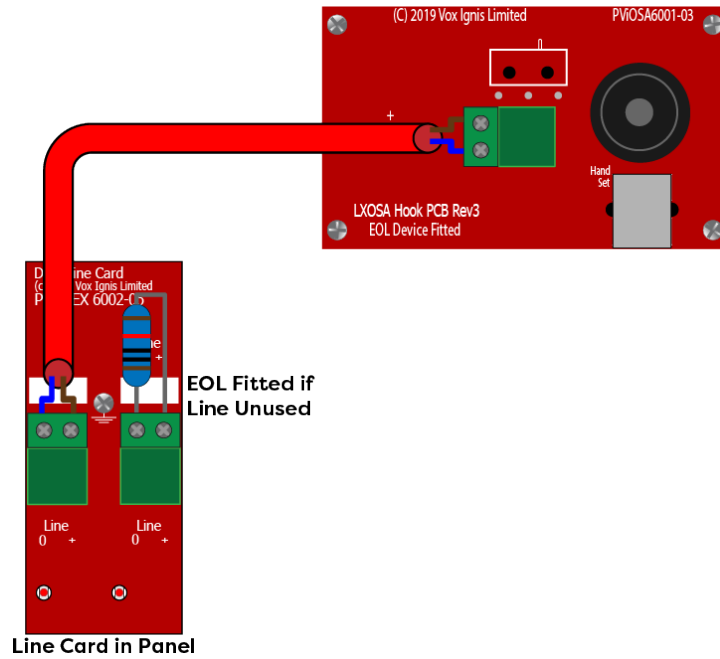

Figure 8



Note: The Earth screen should be sleeved and connected to the terminal block in the controller, and the earth stud in the Type A outstation.

5.7.2 Type B Outstation

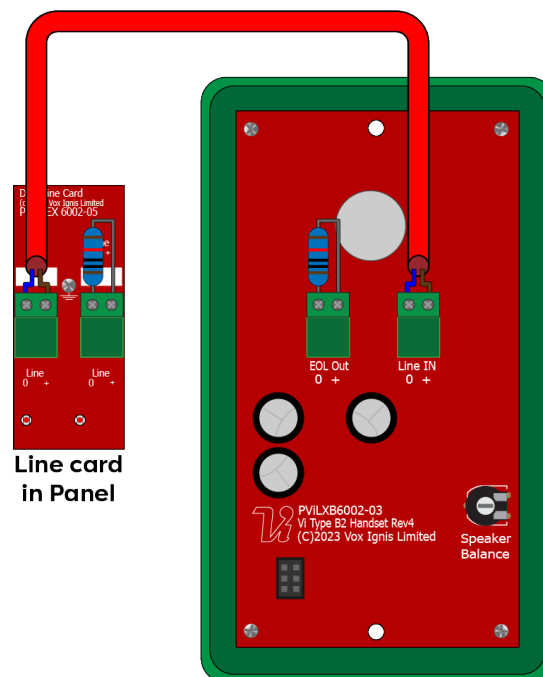

Figure 9



Note: The Earth screen should be sleeved and connected to the terminal block in the controller, and the earth connection in the metal back box (if a plastic back-box is used cut the earth back and insulate at the outstation).

5.7.3 ACA Accessible Toilet Kit

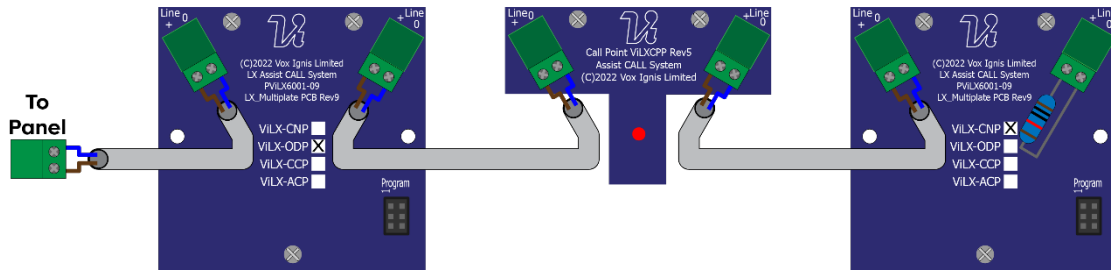

Figure 10

The AssistCall ACA kit comprises an Over Door Indicator, a Pull Cord, and a Cancel Plate. The above order is a typical order; with the Over Door Indicator, Pull Cord and the Cancel Plate connected as shown, but the plates can be wired in any order, as long as the EOL resistor goes into the free terminal of the last plate.

5.7.1 Accessible Toilet connection via Type B outstation

It is possible to connect the AssistCall ACA Kit to the Vox ignis Type B outstation. The kit is connected as shown in the schematic in Figure 10, it is connected to the EOL Out Terminal. It must be wired using the same integrity cable as the type b outstation to meet BS 5839-9:2021.

Note We do not recommend this connection method in schools or similar premises where it is likely the disabled refuge system is isolated until the fire alarm system is activated. For further information see Technical Bulletin ViTB-002.

5.7.2 Fire telephone jack type connection

The system is fully compatible with Vox Ignis range of jack points and roaming phones. Multiple jack points are wired in series into a line on the 228N panel, with a 10kΩ EOL resistor placed in the final jack point in the line. There are 2× sets of terminals for In and Out connections, the wiring is polarity conscious. Connections for standard ViLX-OSJ jack point shown in Figure 11, with the ViLX-OSJ-S switched jack point shown in Figure 12.

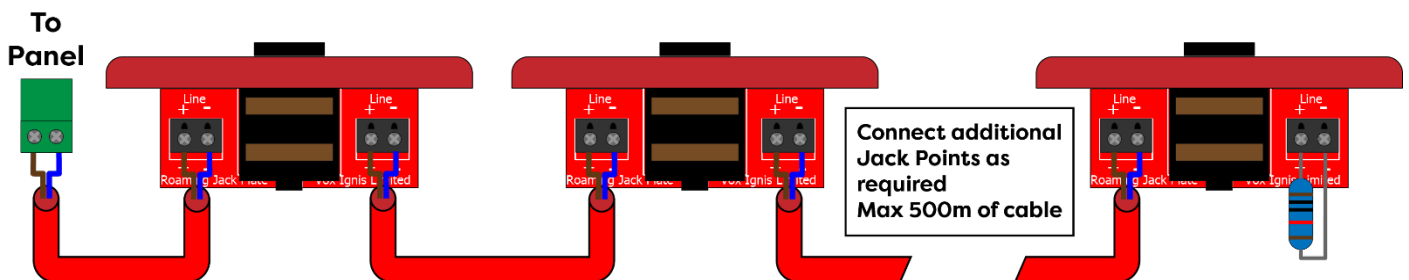

Figure 11

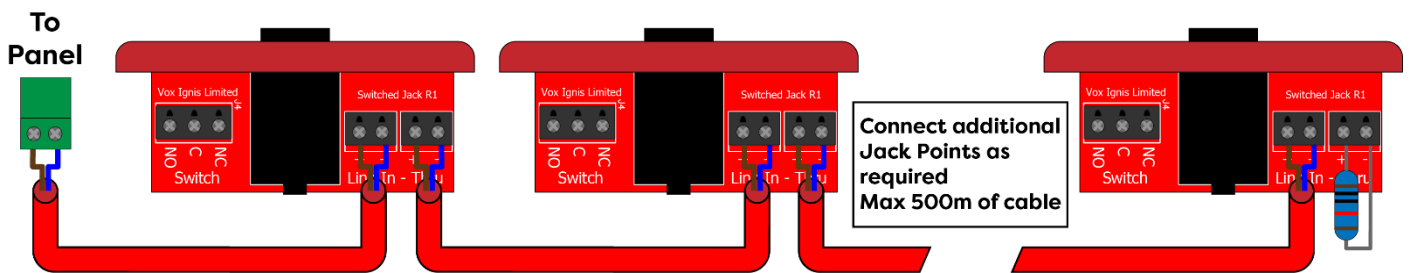

Figure 12

5.8 Auxiliary Connections

The 228N has three auxiliary connections:

Fault is a normally CLOSED volt free relay (30V DC 1A) which OPENS on any fault on the network, including loss of power

In Use is a normally OPEN volt free relay (30V DC 1A) connection. The relay CLOSES when configured to do so by the 228N (see 6.9), usually when an outstation is operated.

Enable is a normally CLOSED input, and is required to operate the system, this is often connected to the fire alarm system. If Jumper J8 is in place, then no connection is required at the terminals.

It is advised that this feature is not used as the system should always be available, not just during an evacuation.

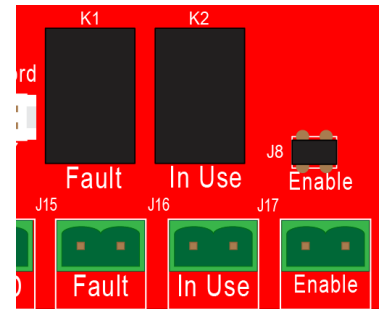

Figure 13

If this function is used, then the removal of Jumper J8 and opening the **Enable** input, will not display incoming calls from Type B outstations only. Calls from Type B outstations automatically “time out” after approximately 30 minutes. Type A outstations and AssistCall emergency assistance alarm systems will continue to operate. If this feature is utilised, then the mode LED illuminates yellow after 30 seconds to show that the system is disabled.

Note: *If the system is disabled, the master station can still make outgoing calls.*

If this function is used, it only requires connection with one panel on the network. If the **Enable** input is CLOSED on one panel, then all panels on the network are CLOSED. To disable Type B outstations, then the **Enable** input on all panels on the network must be OPEN.

5.9 Powering up procedure

To power up the ViLX-228N Master Station, carefully check all internal wiring before applying mains power to the ViLX-228N Master Station. Once the ViLX-228N Master Station is powered, the battery can be attached using the battery leads supplied. When attaching the battery, always attach the Positive (Red+) terminal first.

5.10 Powering down procedure

To power down the ViLX-228N Master Station, first disconnect the battery. Always disconnect the Negative (Black -) terminal first. Once the battery leads have been disconnected, then remove mains power.

6 Set-up Procedure

The ViLX-228N Master Station has various site configurations which are configured using the dipswitch located on the rear of the Display PCB.

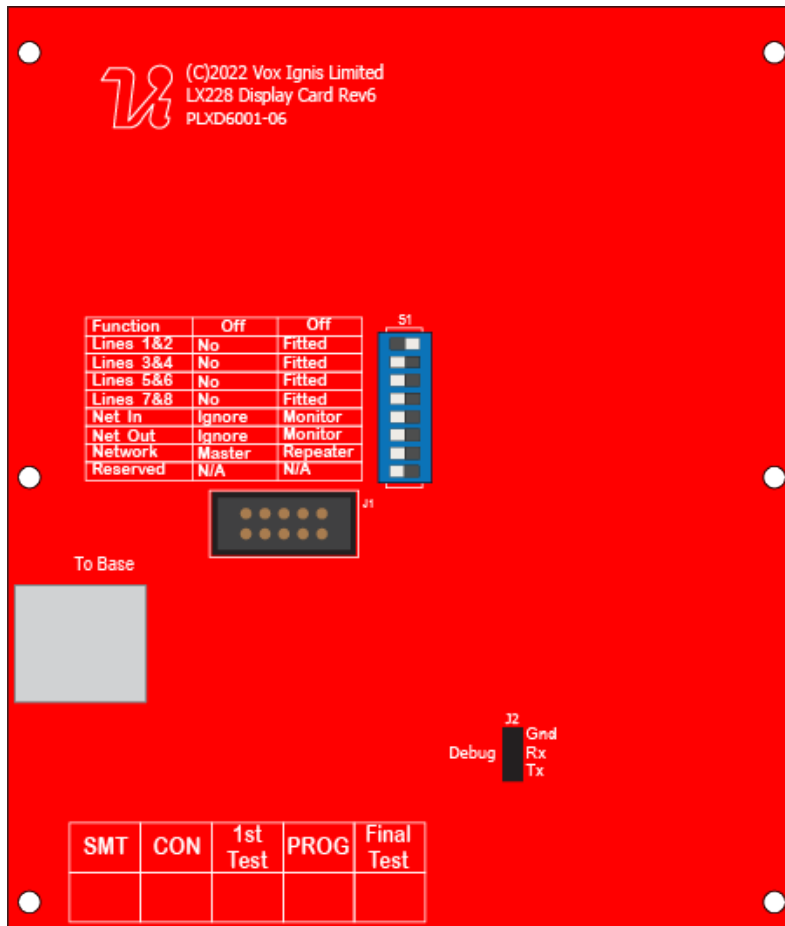

Figure 14

6.1 ViLX-228N Master Station Display PCB Dipswitch Settings

Remarks	1 - Line 1&2	2 - Line 3&4	3 - Line 5&6	4 - Line 7&8	5 - Net In	6 - Net Out	7 - Network	8 - Reserved
Line card 1 fitted to panel	✓							N/A
Line card 1, 2 fitted to panel	✓	✓						
Line card 1, 2, 3 fitted to panel	✓	✓	✓					
Line card 1, 2, 3, 4 fitted to panel	✓	✓	✓	✓				
Default single Master					x	x	x	
Ring connected Master					✓	✓	x	
Ring connected Repeater					✓	✓	✓	

Table 1

✓ = Dipswitch in ON position

x = Dipswitch in OFF position

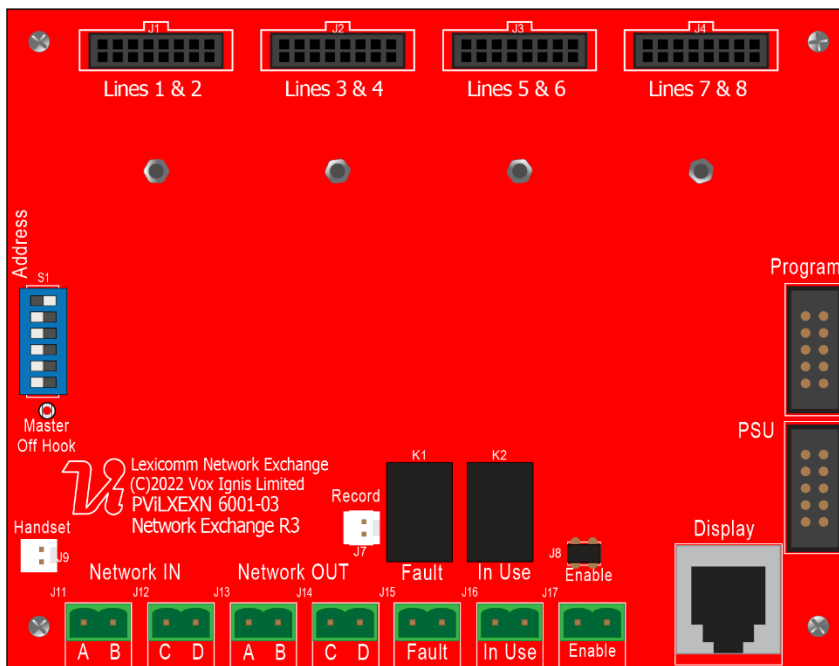

Figure 15

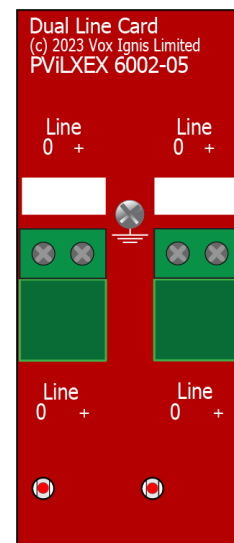

Figure 16

6.2 Adding a Line Card

The ViLX-228N Master Station is supplied with at least **one number** Line Card. There are 2 lines per Line Card. Before adding a Line Card, ensure that the ViLX-228N Master Station is not powered. If the ViLX-228N Master Station is powered, then power down the ViLX-228N Master Station (see 5.10).

To fit the Line Card:

1. Place Line Card in the next available space on the Exchange PCB and secure using the supplied screw.
2. Remove the line terminal and connect the field wiring.
3. Push the terminal into the correct position on the Line Card.
4. Set the dipswitch on the Display PCB (see 6.1) to enable Line Card monitoring.

Once the Line Card is securely fitted, power up the ViLX-228N Master Station (see 5.9).

6.3 Removing a Line card

Before removing a Line Card, ensure that the ViLX-228N Master Station is not powered. If the ViLX-228N Master Station is powered, then power down the ViLX-228N Master Station (see 5.10).

To remove the Line Card:

1. Remove all line terminals from the Line Card that is to be removed.
2. Remove the securing screw.
3. Remove the Line Card from Exchange PCB.
4. Set the dipswitch on the Display PCB (see 6.1) to disable Line Card monitoring.

Once the Line Card has been removed, the ViLX-228N Master Station may be powered (see 5.9).

6.4 Adding a ViLX-228N Repeater Station

The ViLX-228N Master Station has in-built networking which means a single additional ViLX-228N Master Station can be added. This additional ViLX-228N Master Station is designated as the ViLX-228N-0 Repeater Station. The ViLX-228N-0 Repeater Station must be wired as a ring to comply with BS5839pt9:2021

The 4 Line Cards can be distributed between the ViLX-228N Master Station and the ViLX-228N Repeater Station in any combination, as long as the Line Cards do not occupy the same position on the Exchange PCB in both the ViLX-228N Master Station and the ViLX-228N Repeater Station, i.e. if a Line Card is in position 1 (Lines 1&2) on the ViLX-228N Master Station, then **no** Line Card can be placed into position 1 (Lines 1&2) on the ViLX-228N Repeater Station. The line monitoring dipswitches on the rear of the 228 Display should be set according to which line cards are present on the individual panel (i.e. if lines 1-4 are on the Master and 5-8 are on the Repeater, the Master should have dipswitches 1 & 2 on and 3 & 4 off as only line cards 1 & 2 are present on the Master panel).

Network connections used are Network Out and Network In, with Network In on one Station wired to Network Out on the other Station (A to A, B to B, C to C, and D to D).

The default network address setting for the ViLX-228N Master Station is 1. When adding a ViLX-228N -0 Repeater Station, it **must** share the same address as the ViLX-228N Master Station.

ViLX-228N Master Station Exchange PCB Dipswitch Settings

The ViLX-228N Master Station can be integrated with a ViLX-TMS Master Station to form part of a Lexicomm site wide network where the ViLX-228N Master Station provides a local control and wiring position reporting back to the ViLX-TMS.

Each ViLX-228N Master Station on the Lexicomm network has a unique network address. This address is set by the dipswitches on the Exchange PCB. The address is a binary number given by the positions of dip switches 1 to 6, with valid addresses lying between 1 and 64 inclusive.

Addr	1	2	3	4	5	6	Addr	1	2	3	4	5	6
1	1	0	0	0	0	0	33	1	0	0	0	0	1
2	0	1	0	0	0	0	34	0	1	0	0	0	1
3	1	1	0	0	0	0	35	1	1	0	0	0	1
4	0	0	1	0	0	0	36	0	0	1	0	0	1
5	1	0	1	0	0	0	37	1	0	1	0	0	1
6	0	1	1	0	0	0	38	0	1	1	0	0	1
7	1	1	1	0	0	0	39	1	1	1	0	0	1
8	0	0	0	1	0	0	40	0	0	0	1	0	1
9	1	0	0	1	0	0	41	1	0	0	1	0	1
10	0	1	0	1	0	0	42	0	1	0	1	0	1
11	1	1	0	1	0	0	43	1	1	0	1	0	1
12	0	0	1	1	0	0	44	0	0	1	1	0	1
13	1	0	1	1	0	0	45	1	0	1	1	0	1
14	0	1	1	1	0	0	46	0	1	1	1	0	1
15	1	1	1	1	0	0	47	1	1	1	1	0	1
16	0	0	0	0	1	0	48	0	0	0	0	1	1
17	1	0	0	0	1	0	49	1	0	0	0	1	1
18	0	1	0	0	1	0	50	0	1	0	0	1	1
19	1	1	0	0	1	0	51	1	1	0	0	1	1
20	0	0	1	0	1	0	52	0	0	1	0	1	1
21	1	0	1	0	1	0	53	1	0	1	0	1	1
22	0	1	1	0	1	0	54	0	1	1	0	1	1
23	1	1	1	0	1	0	55	1	1	1	0	1	1
24	0	0	0	1	1	0	56	0	0	0	1	1	1
25	1	0	0	1	1	0	57	1	0	0	1	1	1
26	0	1	0	1	1	0	58	0	1	0	1	1	1
27	1	1	0	1	1	0	59	1	1	0	1	1	1
28	0	0	1	1	1	0	60	0	0	1	1	1	1
29	1	0	1	1	1	0	61	1	0	1	1	1	1
30	0	1	1	1	1	0	62	0	1	1	1	1	1
31	1	1	1	1	1	0	63	1	1	1	1	1	1
32	0	0	0	0	0	1	64	0	0	0	0	0	0

Table 2

6.5 Login Procedure

For access level 2 (User) the code is 1664, for access level 3 (Engineer) the code is 1812. Enter the relevant code using the numbered buttons 1-8, as each button is pressed the user LED will flash cyan/magenta faster until the required code is entered, at which point LEDs 1-3 will illuminate cyan for User mode and LEDs 1-5 will illuminate cyan for Engineer mode.

6.6 Fault Accept

Before accepting faults, the fault must be noted in the logbook, along with the time the fault was reported. To accept the fault, enter either the access level 2 (code: 1664) or access level 3 (code: 1812) menu, then press zone button 1. The buzzer will silence, and the general fault LED will now go steady. Press zone button 8 to exit this menu and to return to the menu options. The buzzer will resound on each new fault.

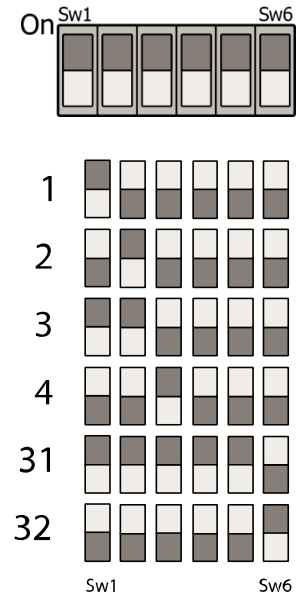

Figure 17

6.7 Panel Indicator Test

To test the panel indicators, enter either the access level 2 (code: 1664) or access level 3 (code: 1812) menu, then press zone button 2.

All LEDs will illuminate in a predefined sequence, and the buzzer will sound.

Press zone button 8 or 2 to stop the panel indicator test and to return to the menu options.

6.8 Extended Fault Menu

Enter the access level 2 code (1664) or access level 3 (code: 1812) then press zone button 3.















Zone	Indicator	Description
1-4		Line card configured as not fitted
		Line card configured as fitted but not present
		Line card configured as fitted and present
5 Net In 6 Net Out		Network port not monitored
		Both network data and audio faults present on port. <i>Flashing between yellow and white</i>
		Network data fault present on port <i>Flashing yellow</i>
		Audio open circuit fault present on port <i>Flashing white</i>
		Audio short circuit fault present on port
		Network port healthy
7		Communication fault between display and exchange <i>Flashing white</i>
		Display system fault present
		Display checksum fault present <i>Flashing yellow</i>
		Display healthy
8		Exchange system fault present <i>Flashing yellow</i>
		Exchange healthy

Table 3

6.9 In Use Relay Options

The In Use Relay has programmable functions which can work in tandem with the delay timer described in 6.9. These functions can provide a relay output as described in the table below:

These relay functions can be useful for providing an output of specific system operation of EVC, AssistCall or both. This relay can also be used to connect to the ViLX-RAP Remote Alarm panel or a remote sounder or beacon which can be configured to cancel operation when the master handset is picked up such that the sounder will not interfere with the conversation.

Enter the access level 3 code (1812), then press button 5 to enter this mode. The magenta zone indicators from 1 to 8 will be illuminated depending on selection. When the required selection has been made press button 8 to exit this mode.

Button	Relay Option
1	Not Used
2	EVCS & AssistCall
3	EVCS only
4	AssistCall Only
5	EVCS, connected conversation
6	Relay activates on any call, Relay de-energises on master handset pickup
7	Relay operates when call not answered /acknowledged (EVCS and AssistCall)
8	Exit

Table 4

6.10 Remote Signal Delay Timer

The in-use relay function can be altered to provide a remote signal via an auto dialler, BMS or similar. This feature works in conjunction with 6.9 In Use Relay Options. The delay is adjustable between up to 3 minutes, in 30 second intervals, such that if a call from an outstation is not answered within the chosen time delay, then the relay operates. This could be used to send a signal off site during periods when the master station is not attended.

If the call is answered during the delay period, the relay will not operate, and the timer will cease.

The above function works identically with the AssistCall emergency assistance system.

Enter the access level 3 code (1812), then press button 4 to enter this mode. The magenta zone indicators from 1 to 8 will be illuminated depending on selection, pressing button 2 will give a 30 second delay, button 3 a one-minute delay and so on to button 7 which gives a three minute delay. Button 1 sets no delay, meaning the relay will operate immediately after the trigger condition is met. When the required delay is selected, the adjacent indicator will illuminate to confirm the delay period. Press button 8 to exit this mode.

Button	Delay Timer Options
1	No Delay
2	30 Secs
3	1 Min
4	1 min 30 secs
5	2 min
6	2 min 30 secs
7	3 min
8	Exit

Table 5

7 Operation

All conversations are under the command of the ViLX-228N Master Station.

7.1 Receiving a Call

One of the eight zone LEDs and the mode LED will flash red to indicate an incoming call. The flash rate will identify the outstation type, with a Type A outstation having a faster flash rate than a Type B outstation.

Lift the Master handset receiver. The User LED will illuminate Red.

Press the corresponding zone button (indicated by the red flashing LED). This LED and the User LED will change to flashing green to show that this line is now connected, and a conversation can take place.

7.2 Making a Call

To make a call, lift the Master handset receiver and the User LED will illuminate red.

Press the zone button for the required outstation. The corresponding zone LED will flash red. This flash rate will be slower than the flash rate for either an incoming Type A or Type B call.

When the outstation answers the call, the zone LED flashes green, the mode LED illuminates red and the user flashes green to indicate this line is now connected and a conversation can take place.

7.3 Ending a Call

To end the call from the outstation, either replace the Type A receiver back on its hook or press the call/cancel button for a Type B outstation.

To end a conversation from the ViLX-228N Master Station, replace the Master handset receiver back on its hook.

Note: This will not end the call, only the conversation. The outstation will revert back to requesting a call, and the zone LED will flash red to indicate this. The call MUST be ended at the outstation.

7.4 Putting a Call on Hold

To put a call on hold, press the zone button for the required outstation that is already connected. The zone LED will change from flashing green to flashing green/red. The hold tone will be heard in the handset.

To reconnect the call, press the zone button for the required outstation again. The zone LED will change from flashing green/red to flashing green to indicate the call is now connected again.

7.5 Conference Call

Depending upon the number of Line Cards fitted in the ViLX-228N Master Station, up to five lines can be connected to the conference call at any one time. To receive a call, see 7.1 To make a call to an individual outstation, see 7.2. The ViLX-228N Master Station controls which lines are involved in the conference, and only one conference group is allowed.

7.6 Acknowledging AssistCall Alarms

When an AssistCall goes into alarm, the appropriate zone LED will flash blue, and a two-tone buzzer sounds to indicate that an AssistCall alarm has been operated.

To acknowledge the alarm, press the corresponding zone button, and the blue LED will illuminate continuously with an intermittent buzzer tone every 15 seconds. If after 2 minutes the AssistCall alarm has not been cancelled, the buzzer will resound, and the LED will flash blue.

Within the WC cubicle the pull cord indicator will change from continuous indication to no indication. The cancel plate will alter from flashing to continuous and the buzzer will change from continuous to intermittent. Outside the cubicle the Over door plate indication will alter from flashing to continuous and the buzzer will change from continuous to intermittent. This change in indication and buzzers during the acknowledge phase indicates to the WC user that help is on the way.

7.7 Accepting Faults

Before accepting faults, the fault must be noted in the log book, along with the time the fault was reported.

To accept the fault, enter either the access level 2 (code: 1664) or access level 3 (code: 1812) menu, then press zone button 1. The buzzer will silence, and the general fault LED will now go steady.

Press zone button 8 to exit this menu and to return to the menu options.

The buzzer will resound on each new fault.

7.8 Panel Indicator Test

To test the panel indicators, enter either the access level 2 (code: 1664) or access level 3 (code: 1812) menu, then press zone button 2.

All LEDs will illuminate in a predefined sequence, and the buzzer will sound.

Press zone button 8 to stop the panel indicator test and to return to the menu options.

8 Indications and Controls

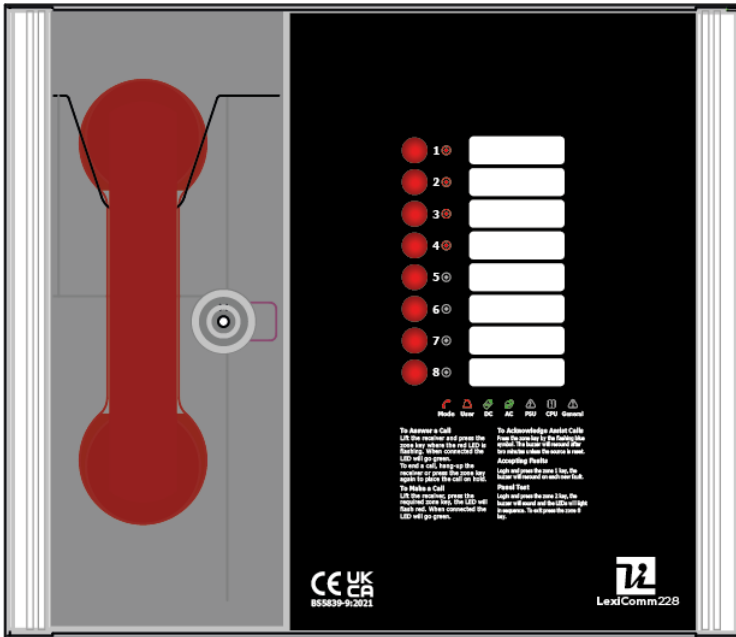

Figure 18

8.1 Indicator Icons Key

LED off	LED illuminated a single colour	LED flashing on and off	LED flashing between two colours

Table 6

8.2 Mode Indicator Summary

Mode LED	Description	Mode LED	Description
	Normal state		Outstation off hook and assistance alarm active at same time
	Outstation off hook		Refuge (Type B) points disabled
	Assistance alarm active		Panel in fault

Table 7

8.3 Power Supply and CPU Indicator Summary

DC LED	AC LED	PSU LED	CPU LED	Description
				Mains and battery OK
				Mains failure
				Battery open circuit
				Battery short circuit
				Battery high impedance
				PSU system fault
				Display / Exchange system fault or display-exchange comms fault
				Remote battery fault
				Remote mains fault

Table 8

8.4 User Indicator Summary

User LED	Description	User LED	Description
	Idle		User logged in
	Master handset off hook		Engineer logged in
	Master handset open circuit		Call connected
	Master handset short circuit		Call on hold
	Login in progress		

Table 9

8.5 Zone Indicator Summary

















Zone LED	User LED	Buzzer	Description
		Off	Outgoing call
		Ringing	Incoming Type A call
		Ringing	Incoming Type B call
		Off	Call connected to master handset
		Off	Call on hold
		2 – tone alarm	Incoming alarm
		Intermittent double beep	Alarm acknowledged
		Fault tone	Line short circuited
		Fault tone	Line card missing
		Fault tone	Line open circuit or EOL missing
		Fault tone	Line Earth Fault
		Off	Access level 2
		Off	Access level 3

Table 10

The flash rates for the line LEDs are described below:



Flashing at same rate as Mode LED	Flashing at a faster rate than the Mode LED	Flashing at a slower rate than the Mode LED
		

Table 11

9 Commissioning Procedure

The commissioning should be carried out by a competent person who has a basic knowledge and understanding of the design and installation sections of BS 5839-9:2021 and has access to the specification of the project.

9.1 Cable Checks

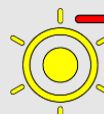
The 500V insulation tests should have been carried out by the installer and the results made available to the commissioning engineer.

All cables should be correctly labelled.

Test field wiring and check for end-of-line 10kΩ resistor. Check cables are clear from any short or open circuits.

Connect cables into Line Cards.

9.2 Set up, Power up

Configure relevant dipswitches for the number of Line Cards fitted, these should have been factory set.

Power up the ViLX-228N Master Station using mains only, fed via a double fitted in an unswitched fused spur. The AC power indicator will be illuminated, and the DC power indicator is extinguished. The PSU fault and General fault indicators will be illuminated. There should be no line fault indicators illuminated.

If there are no line faults present, the battery may be connected. The DC power indicator will be illuminated, and the PSU fault and General fault indicators are extinguished when battery is connected.

If there are any line fault indicators illuminated, then the field wiring should be checked prior to the battery being connected.

9.3 Intelligibility Tests

Lift the master handset receiver and listen for a cadence tone.

An intelligibility test will need to be performed when the system is complete, and the building has normal background noise levels. The intelligibility test requires two personnel.

One person should be present at the master station; the other person should visit each outstation in turn and put the outstation into call. The master station operator should check the location of the outstation is correct and have a conversation, the master station operator should then call the outstation back to check the reverse operation.

9.4 AssistCall Checks

Where AssistCall is fitted, all pull cords in each circuit should be tested, acknowledged at the panel, cancelled at the call location. Ensure all controls and indicators operate correctly.

10 Maintenance

It is a requirement of BS 5839-9:2021 that a maintenance agreement be in place for the EVCS. The maintenance schedule should be as follows:

Frequency	Test
Weekly	Test a different outstation on the system each week and make a call to the control. Repeat each week until all outstations and master stations are tested. Record these results in the site log. *if more than one master station is present alternate weekly.
Biannually	Engineer call to check system operation, intelligibility, field strength of attached AFILS equipment and check battery health. Record results and any variations into the site Log Book
Yearly	Engineer call to check system operation perform 100% outstation and master station operation, field strength of attached AFILS equipment and check battery health. Record results and any variations into the site Log Book.
5 Yearly	In addition to Yearly tests replace all batteries and record in Log Book.

Table 12

11 Outstation zone template

There is space to the right of each outstation zone indicator to name the location of the outstation. At the rear of the display door there is a slot located in the centre above the display PCB; the outstation zone template can be inserted here.

The template is in "Word" format and can be down loaded at www.vox-ignis.com. This can be completed, printed out and cut to size as shown below.



TAB
Refuge 1 Name Toilet 1 Name
Refuge 2 Name Toilet 2 Name
Refuge 3 Name Toilet 3 Name
Refuge 4 Name Toilet 4 Name
Refuge 5 Name Toilet 5 Name
Spare 1
Spare 2
Spare 3

Figure 19

12 Technical Specification

DETAILS ViLX-228N

POWER SUPPLY AND CHARGER

AC Input	230V AC \pm 10% 50/60Hz
Internal supply	5V, 16V, 27V DC
Supply and battery	Monitored Open, Short, Fuses, High Impedance
Protection	Deep discharge, Short, Thermals
Battery type	1 \times 12V 7AH VRSLA
Mains fuse	240V 1A HRC
Battery fuse	750mA PTC
Max charge current	680mA

INPUTS

Lines	2-8 in 2 line blocks
Remote enable	Short to use
End of line	10k Ω

OUTSTATION CABLES

Type	Standard* / Enhanced
Cores	1 \times 2 core radial 1mm or 1.5mm
Distance	500m from master station

OUTPUTS

Number	2, Fault & In use
Fault Relay	1 \times Volt free NC, Com 30V DC 1A
In Use Relay	1 \times Volt free NO, Com 30V DC 1A

CONTROLS AND INDICATIONS

Navigation Buttons	8 push button zone keys
Statutory indicators	8 \times RGB line indicators
	3 \times PSU status indicators
	1 \times CPU fault indicator
	1 \times General fault indicator
	1 \times RGB mode indicator
	1 \times User status indicator

NETWORK CABLES

Type	Standard* / Enhanced
Cores	2 \times 2 core loops, 1mm or 1.5mm (2C Data, 2C Audio)
Distance	500m max between panels

STANDARDS COMPLIANCE

EMC	EN 55035:2017+A11:2020 EN 55032:2015+A1:2020
LVD	EN IEC62368-1:2020+A11:2020
Product Family	BS 5839-9:2021, BS 9999:2017, BS 8300-2:2018

DIMENSIONS

	Panel	Bezel	Cut-out
Height	300mm	350mm	305mm
Width	350mm	400mm	355mm
Depth	95mm	1mm	85mm
Weight	4.5kg		

*Refer to BS 5839-9:2021 for exceptions

The Lexicomm ViLX-288N EVCS is designed and manufactured in the UK by:

Vox Ignis Limited
Unit 87 Alexandra Avenue
Sunderland Enterprise Park
Sunderland
Tyne & Wear
SR5 2TB

Company Registration No: 8892407

www.vox-ignis.com

info@vox-ignis.com



WEEE
Compliant
Product

All information is believed to be correct at time of printing E&OE.
Vox Ignis operate a policy of continuous improvement; always confirm specification details before purchase.
Company Registration No: 8892407 info@vox-ignis.com
Document DViLX228N1002-02

